

INSTRUCTION MANUAL
for installing
39.3300 Series
UNDERMOUNT SLIDE

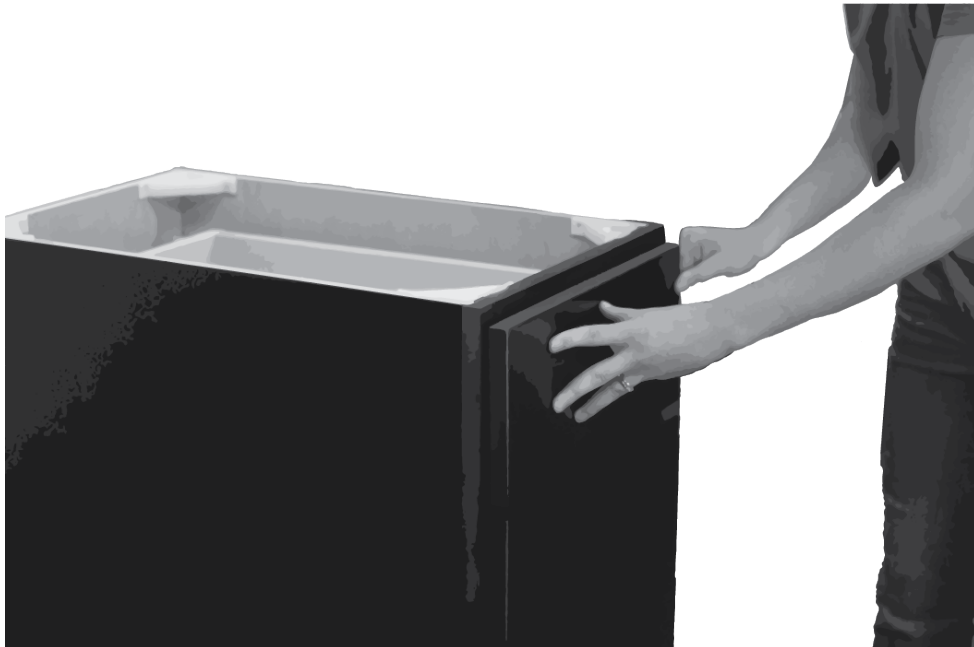

The **CABINET DOOR** Store

Tools and Hardware Recommended:

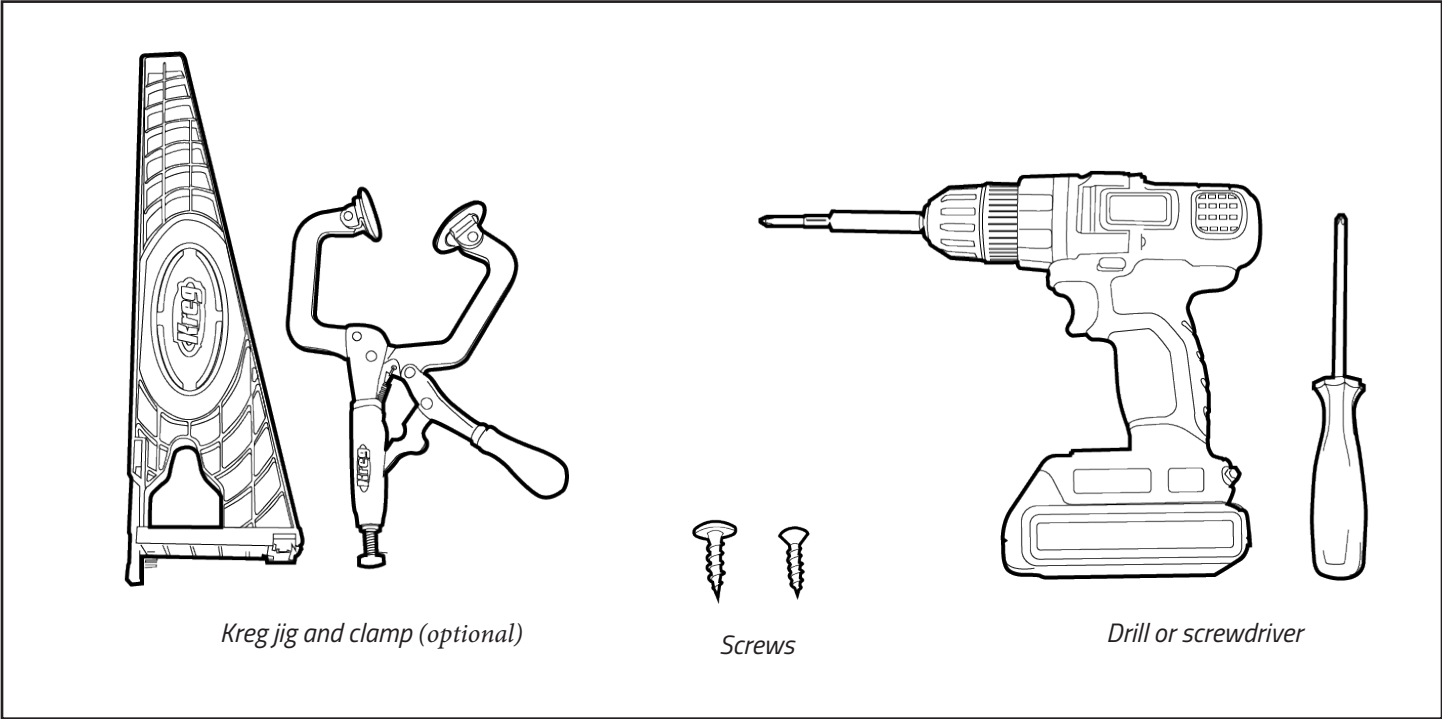

Hardware Included:

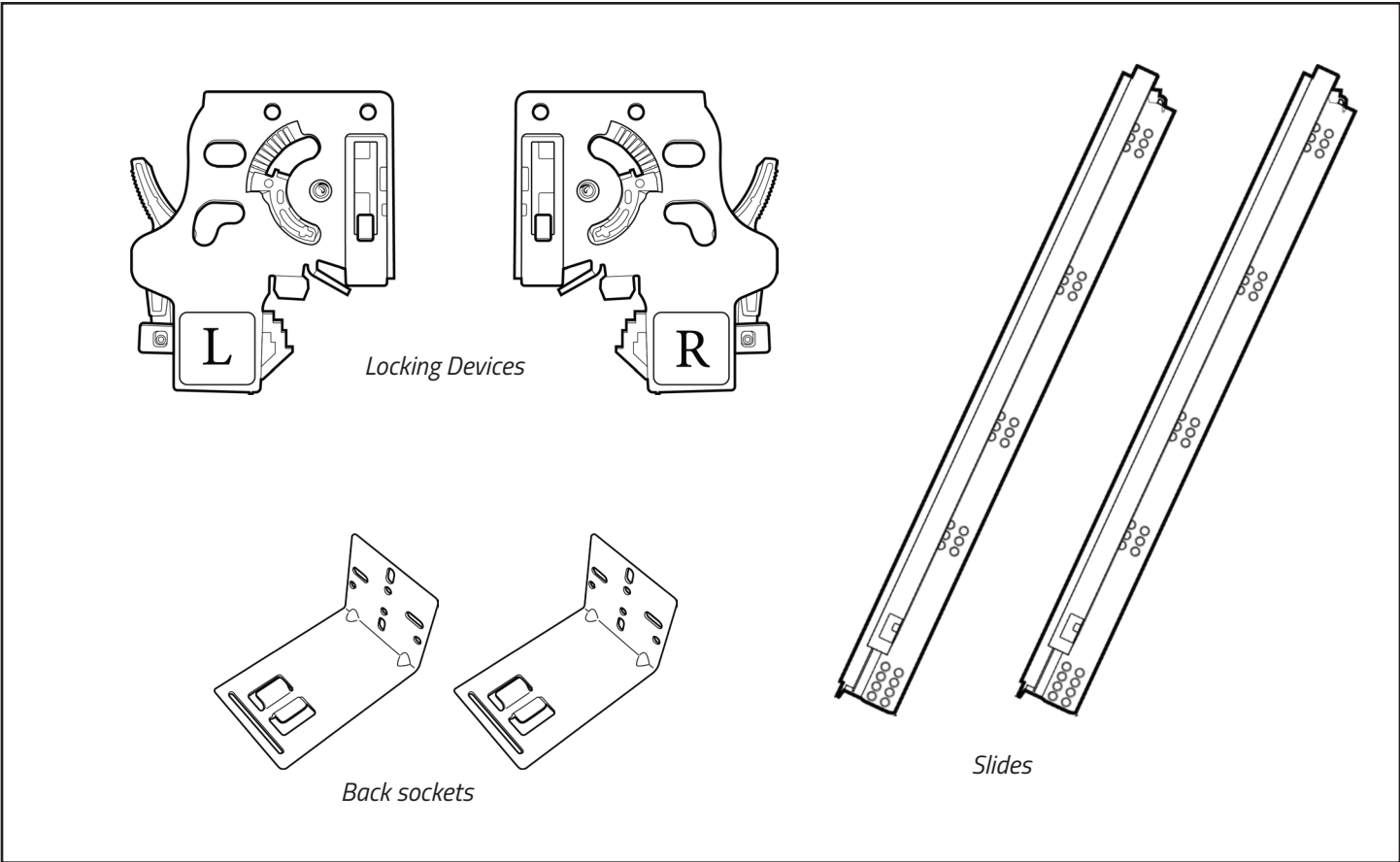

Building the Drawer Box

Minimum/Maximum Cabinet Depth

Drawer box length		Min-Max cabinet depth with metal rear attachment	
229 mm	9"	250–300 mm	9 ⁷ / ₈ –11 ³ / ₄ "
305 mm	12"	326–376 mm	12 ⁷ / ₈ –14 ³ / ₄ "
381 mm	15"	402–452 mm	15 ⁷ / ₈ –17 ³ / ₄ "
457 mm	18"	478–528 mm	18 ⁷ / ₈ –20 ³ / ₄ "
533 mm	21"	654–604 mm	21 ⁷ / ₈ –23 ³ / ₄ "

STEP 1)— Choose Drawer Slide Length

Determine the drawer slide length you will need. Typically, a 24" base cabinet will use a 21" drawer slide, a 21" vanity will use an 18" drawer slide, and a drawer in miscellaneous furniture (bedroom, dining room, etc.) will use a 15" drawer slide.

STEP 2)— Build Drawer Box (If Necessary)

Measure depth and width of box. Use ¹/₂" or ⁵/₈" thick drawer box material

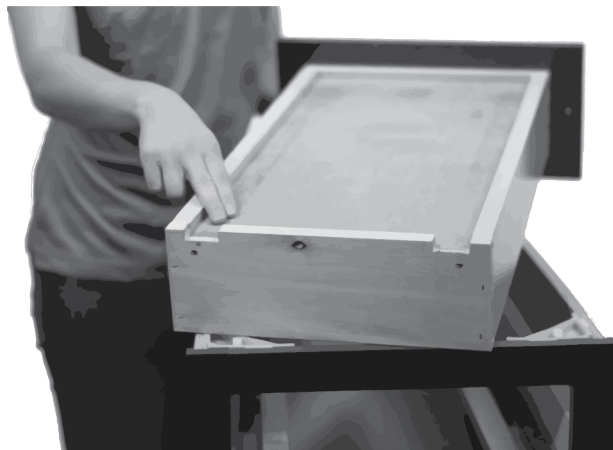
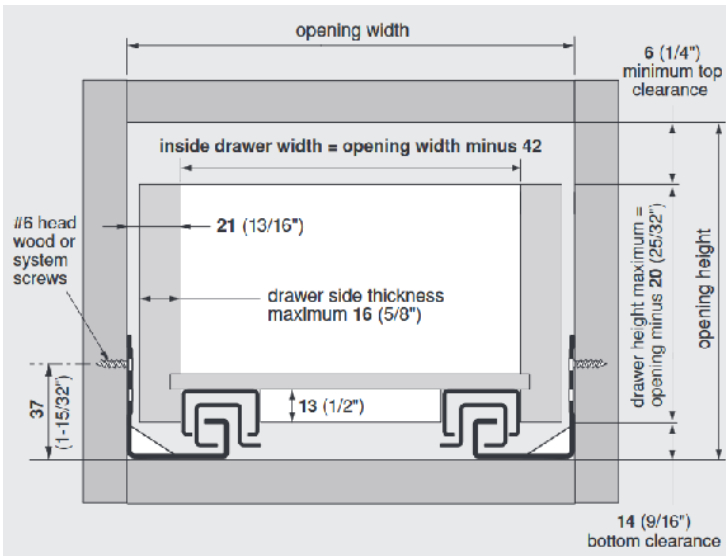

STEP 3)

If necessary, cut notches for the slides, into the back of the drawer box.

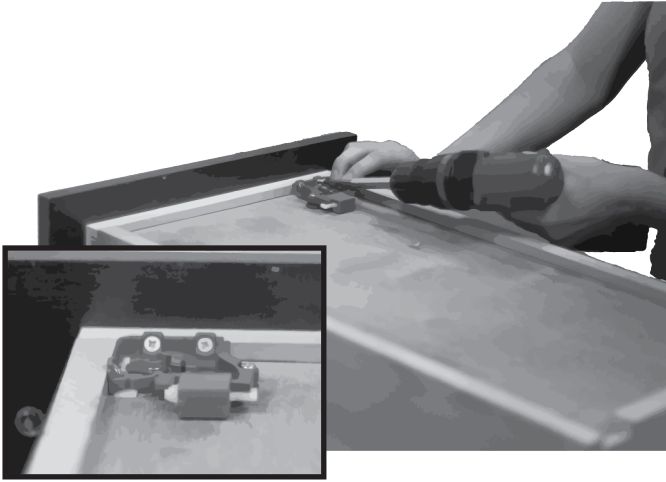

STEP 4)

Install locking devices, which should align inside the bottom front of the drawer box. Screw them into place. Avoid screwing the devices into the bottom of the draw box to keep the screws from puncturing the drawer.

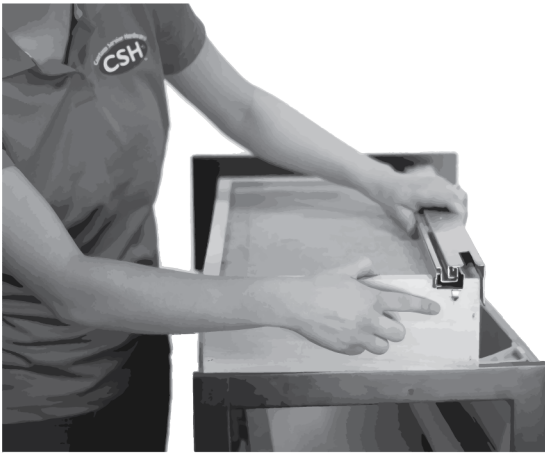

STEP 5)

Drill a $\frac{1}{4}$ " diameter by $\frac{3}{8}$ " deep hole into the drawer back for the metal locator tabs

Installing the Slides



STEP 6a)—Face Frame

We recommend that you use a jig (such as a Kreg Drawer Slide Jig) to make sure you install the slide square and level. If you don't have one, however, you can make do with careful measuring and marking. Screw the slide to the face frame first, setting the slide back $\frac{1}{8}$ " from the front edge of the cabinet (to allow room for the drawer to close). Next, after verifying that the slide is level, screw the back socket to the back of cabinet.



STEP 6b) — Frameless

Frameless: For a frameless cabinet, simply screw the slide into the side of the cabinet, also setting it back $\frac{1}{8}$ ". Again, using a jig will make it easier to keep the slide level, but measuring and marking will also work.

Note: image depicts a face frame cabinet that has been modified to demonstrate frameless installation.

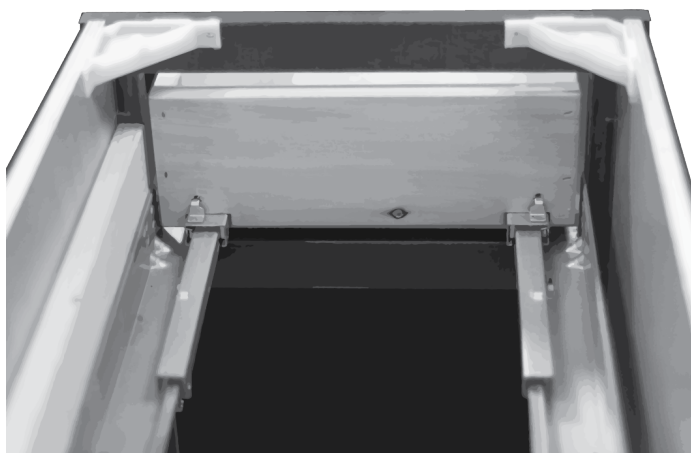

STEP 7)

Place the drawer on the rails, paying attention to line up the notches and holes in the back of the drawer.



STEP 8)

Push the drawer to the back of the cabinet until you hear it lock into place.

If you need more information or help installing your drawer slides, please give us a call at 800-257-8263